

AMBYENTA

...kroz život zajedno...

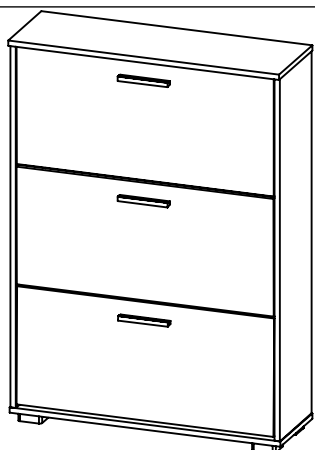





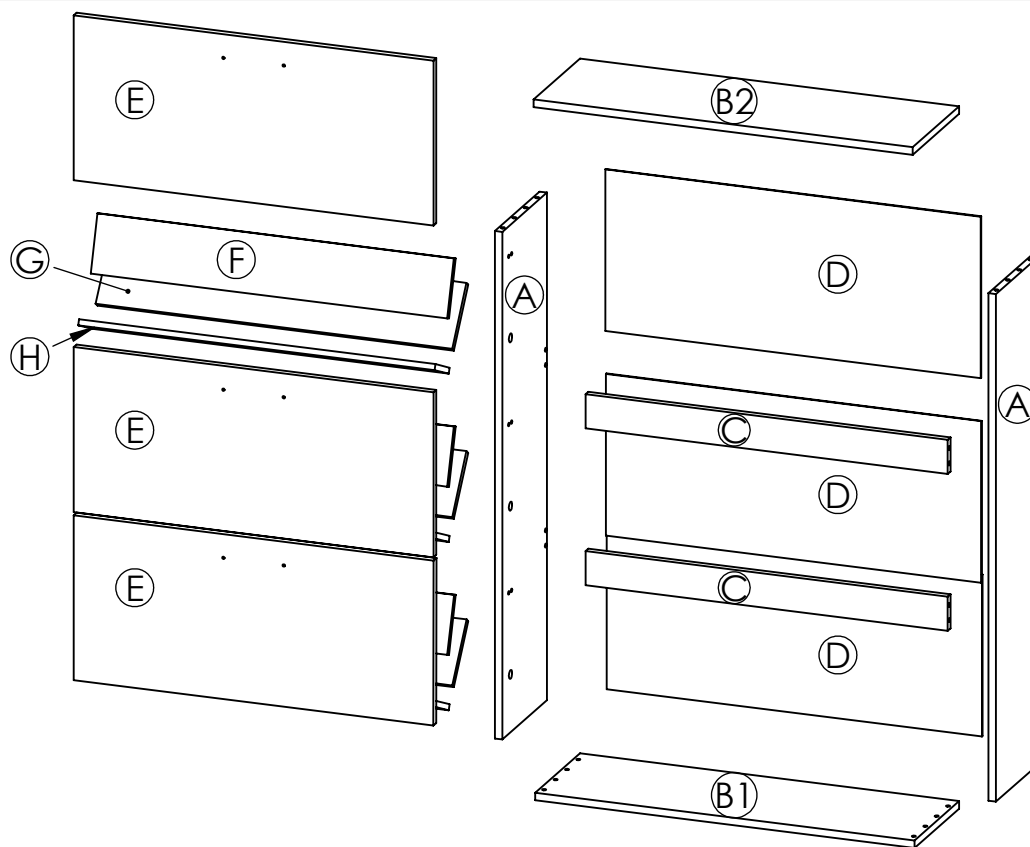
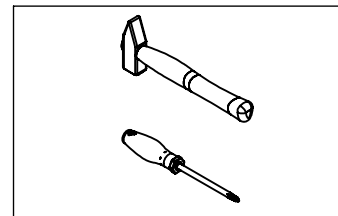
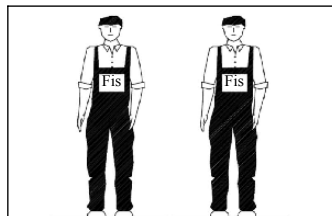

www.ambyenta.com

UPUTSTVO ZA MONTAŽU



Cipelar " ELA / 3V-80"

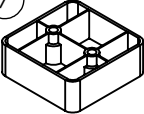
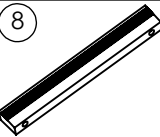
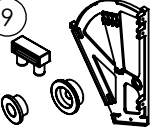

1  Bočica ljepila 1 kom	2  Drvena tipla 8x32 24 kom	3  Vijak 4x16 mm 30 kom	4  Vijak 4x20 mm 8 kom	5  Vijak 3x16 mm 18 kom	6  Vijak 6,3x13 mm 6 kom	7  Nogica - 4 kom	8  Ručkica L=128mm 3 kom
9  PVC nosač L/D 3 para	10  Vijak M4x20 mm 6 kom	11  Ekseri - 30 kom					

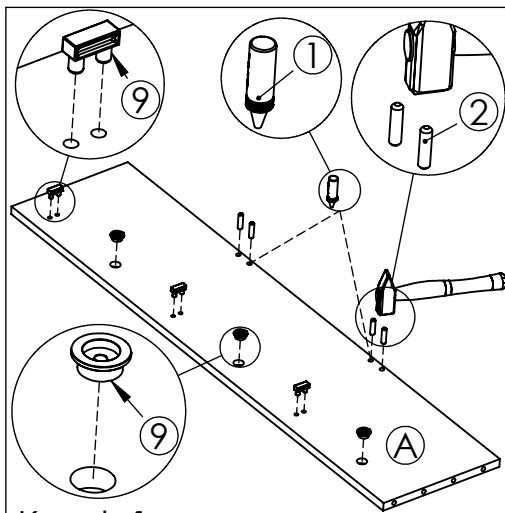

Korak 1

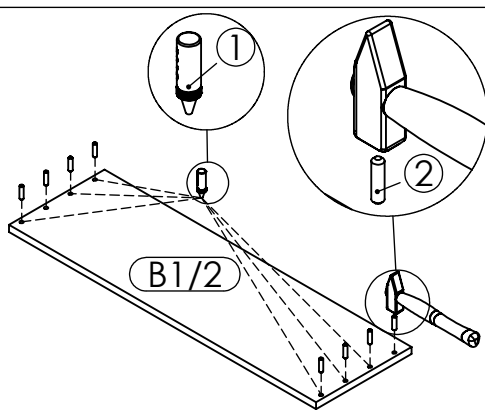

Korak 2

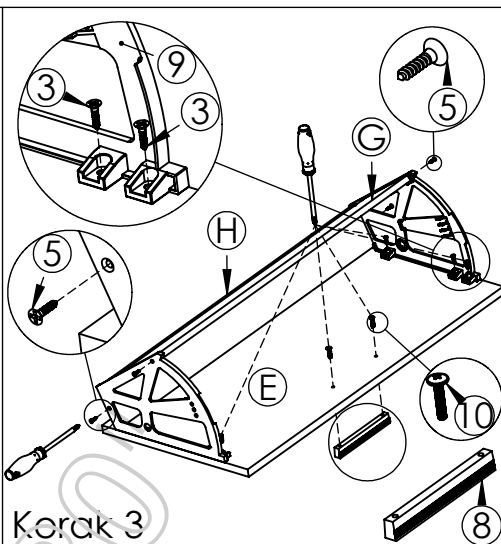

Korak 3

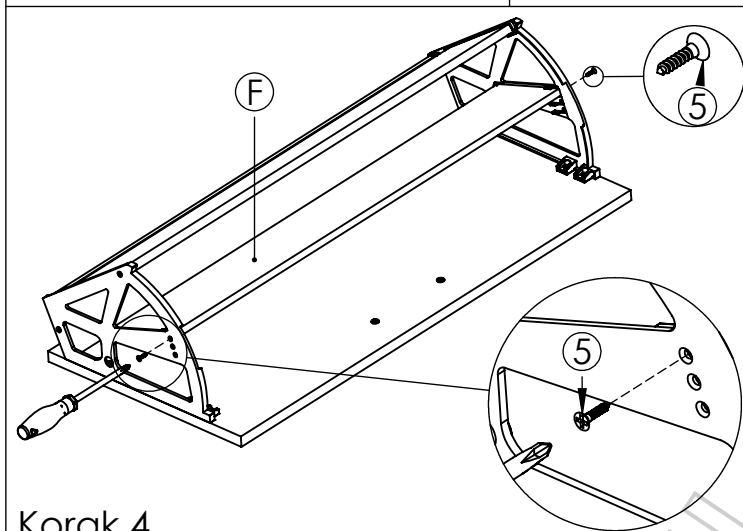

Korak 4

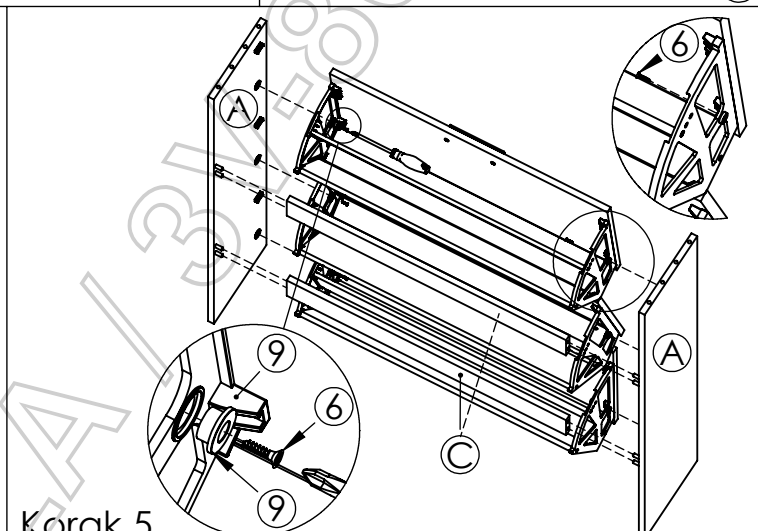

Korak 5

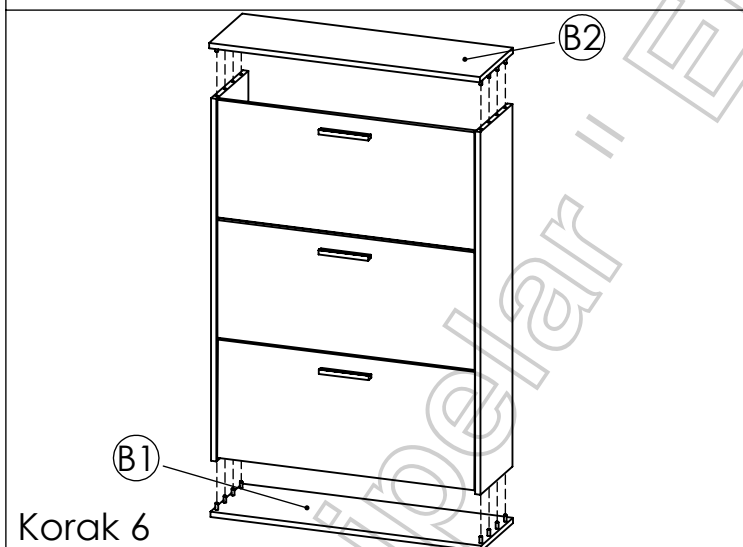

Korak 6

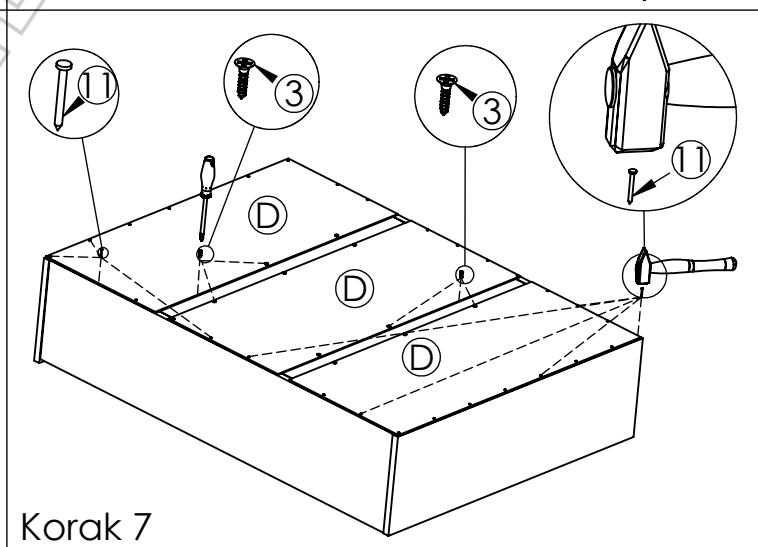

Korak 7

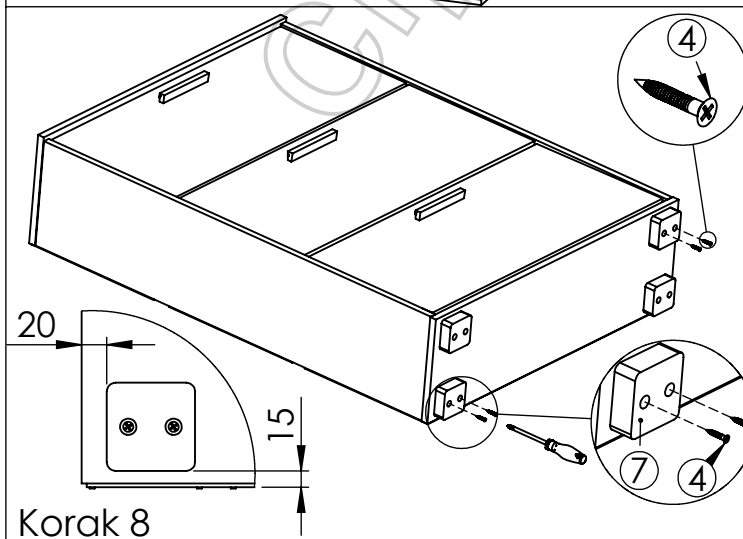

Korak 8



Korak 9